

SPECIFIKACE / SPECIFICATION / SPEZIFIKATION

| | |
|---|--|
|     | <p>PMEC spol. s r.o. nám. Republiky 8, 787 01 Šumperk, Czech Republic Phone 00420 583 216 582 www.pmec.cz info@pmec.cz</p> |
|---|--|

| | |
|--|----------------------|
| TYPOVÉ OZNAČENÍ / ARTICLE NUMBER / ARTIKELNUMMER | DATUM / DATE / DATUM |
|--|----------------------|

| | |
|-------------------------------|-------------------|
| PMEC 323/Vi 180u 2,5 A | 2010-08-23 |
|-------------------------------|-------------------|

| | |
|--|---|
| POPIS / DESCRIPTION / BEZEICHNUNG |  |
| Akumulační tlumivky Storage chokes Speicherdrosseln | |

ROZMĚRY (ZDOLA) / DIMENSIONS (FROM BELLOW) / ABMESSUNGEN (VON UNTEN)

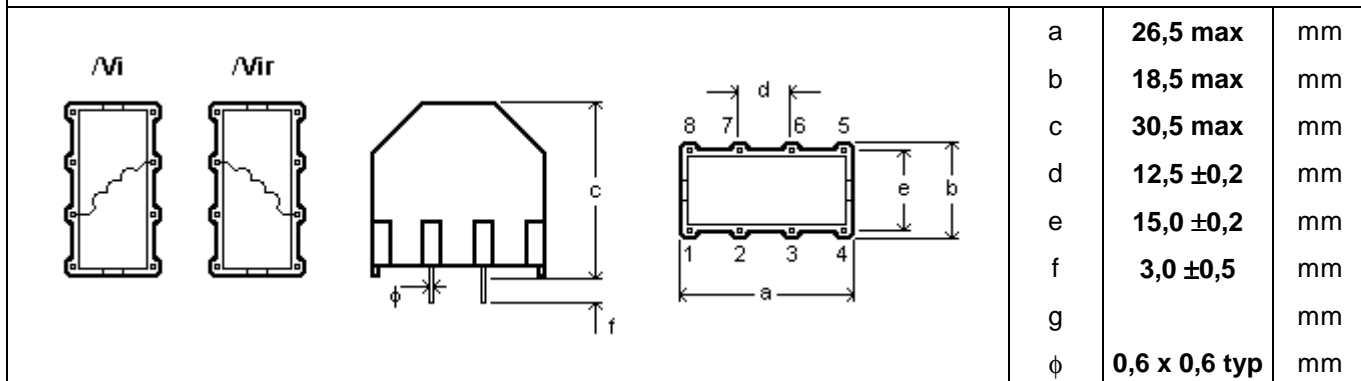

ELEKTRICKÉ VLASTNOSTI / ELECTRICAL PROPERTIES / ELEKTRISCHE EIGENSCHAFTEN

| | | | | | |
|---|----------------------|-----------------------|------------|-----------|---------------|
| MĚŘICÍ PODMÍNKY TEST CONDITIONS MESSBEDINGUNGEN | 10 kHz, 50 mV, 25 °C | L_o | 180 | μH | ± 20 % |
| | | I_N | 2,5 | A | max |
| | 25 °C | R_{DC} | 90 | mΩ | typ |
| | | | | | |

JINÉ VLASTNOSTI / OTHER PROPERTIES / ANDERE EIGENSCHAFTEN

| | | | | |
|----------------------------|----------------|---|----------------------------------|--|
| JÁDRO CORE KERN | Sendust | KLIMATICKÁ ODOLNOST CLIMATIC CATEGORY KLIMABESTÄNDIGKEIT | 40/125/21 | SCHVÁLENO APPROVED KONTROLLIERT  |
| POUZDRO CASE GEHÄUSE | UL94V-0 | ZKUŠEBNÍ NAPĚTÍ TESTING VOLTAGE PRÜFSPANNUNG | | |
| ZALITÍ RESIN VERGUß | UL94V-0 | JMENOVITÉ NAPĚTÍ RATED VOLTAGE NENNSPANNUNG | | |
| DRÁT WIRE DRAHT | UL94V-0 | OTEPLENÍ OVERTEMPERATURE ÜBERTEMPERATUR | < 55 °C | |
| | | IZOLAČNÍ ODPOR INSULATING RESISTANCE ISOLATIONSWIDERSTAND | 50 MΩ, 500 V_{DC} | |

THE CHOKES ARE DESIGNED AND TESTED IN ACCORDANCE WITH EN 60938-1.
 THE CASES ARE OF FLAME-RETARDANT PLASTIC MATERIAL IN ACCORDANCE WITH UL 94V-0.