

# SPECIFIKACE / SPECIFICATION / SPEZIFIKATION

   	<p><b>PMEC spol. s r.o.</b>                  nám. Republiky 8, 787 01 Šumperk, Czech Republic                  Phone 00420 583 216 582                  www.pmec.cz info@pmec.cz</p>
---	--

TYPOVÉ OZNAČENÍ / ARTICLE NUMBER / ARTIKELNUMMER	DATUM / DATE / DATUM
--	----------------------

<b>PMEC 323/H 1m0 0,8 A</b>	<b>2010-08-23</b>
-----------------------------	-------------------

POPIS / DESCRIPTION / BEZEICHNUNG	
-----------------------------------	--

<b>Akumulační tlumivky</b> <b>Storage chokes</b> <b>Speicherdrosseln</b>	
--	---

ROZMĚRY (ZDOLA) / DIMENSIONS (FROM BELLOW) / ABMESSUNGEN (VON UNTEN)
--

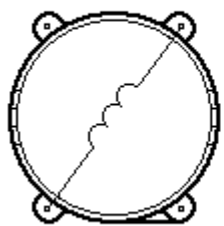
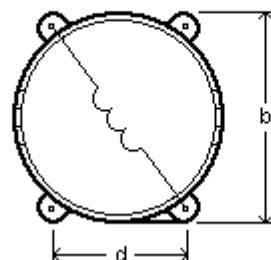
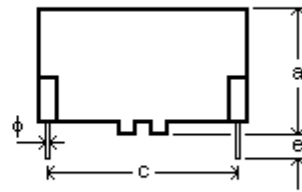
/H	/Hr				
			a	<b>17,0 max</b>	mm
			b	<b>28,5 max</b>	mm
			c	<b>25,2 ±0,2</b>	mm
			d	<b>15,1 ±0,2</b>	mm
			e	<b>3,0 ±0,5</b>	mm
			f		mm
			g		mm
			φ	<b>0,6 x 0,6 typ</b>	mm

ELEKTRICKÉ VLASTNOSTI / ELECTRICAL PROPERTIES / ELEKTRISCHE EIGENSCHAFTEN
---

MĚŘICÍ PODMÍNKY TEST CONDITIONS MESSBEDINGUNGEN	10 kHz, 50 mV, 25 °C	<b>L<sub>o</sub></b>	<b>1,0</b>	<b>mH</b>	<b>± 20 %</b>
		<b>I<sub>N</sub></b>	<b>0,8</b>	<b>A</b>	<b>max</b>
	25 °C	<b>R<sub>DC</sub></b>	<b>90</b>	<b>mΩ</b>	<b>typ</b>

JINÉ VLASTNOSTI / OTHER PROPERTIES / ANDERE EIGENSCHAFTEN				SCHVÁLENO APPROVED KONTROLLIERT	
---	--	--	--	---------------------------------------	--

JÁDRO CORE KERN	<b>Sendust</b>	KLIMATICKÁ ODOLNOST CLIMATIC CATEGORY KLIMABESTÄNDIGKEIT	<b>40/125/21</b>		
POUZDRO CASE GEHÄUSE	<b>UL94V-0</b>	ZKUŠEBNÍ NAPĚTÍ TESTING VOLTAGE PRÜFSPANNUNG			
ZALITÍ RESIN VERGUß	<b>UL94V-0</b>	JMENOVITÉ NAPĚTÍ RATED VOLTAGE NENNSPANNUNG			
DRÁT WIRE DRAHT	<b>UL94V-0</b>	OTEPLENÍ OVERTEMPERATURE ÜBERTEMPERATUR	<b>&lt; 55 °C</b>		
		IZOLAČNÍ ODPOR INSULATING RESISTANCE ISOLATIONSWIDERSTAND	<b>50 MΩ, 500 V<sub>DC</sub></b>		

THE CHOKES ARE DESIGNED AND TESTED IN ACCORDANCE WITH EN 60938-1.  
 THE CASES ARE OF FLAME-RETARDANT PLASTIC MATERIAL IN ACCORDANCE WITH UL 94V-0.