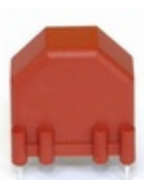

SPECIFIKACE / SPECIFICATION / SPEZIFIKATION

   	<p>PMEC spol. s r.o. nám. Republiky 8, 787 01 Šumperk, Czech Republic Phone 00420 583 216 582 www.pmec.cz info@pmec.cz</p>
---	--

TYPOVÉ OZNAČENÍ / ARTICLE NUMBER / ARTIKELNUMMER	DATUM / DATE / DATUM
--	----------------------

PMEC 322/Ve 180u 1,4 A	2010-08-23
-------------------------------	-------------------

POPIS / DESCRIPTION / BEZEICHNUNG	
Akumulační tlumivky Storage chokes Speicherdrosseln	

ROZMĚRY (ZDOLA) / DIMENSIONS (FROM BELLOW) / ABMESSUNGEN (VON UNTEN)

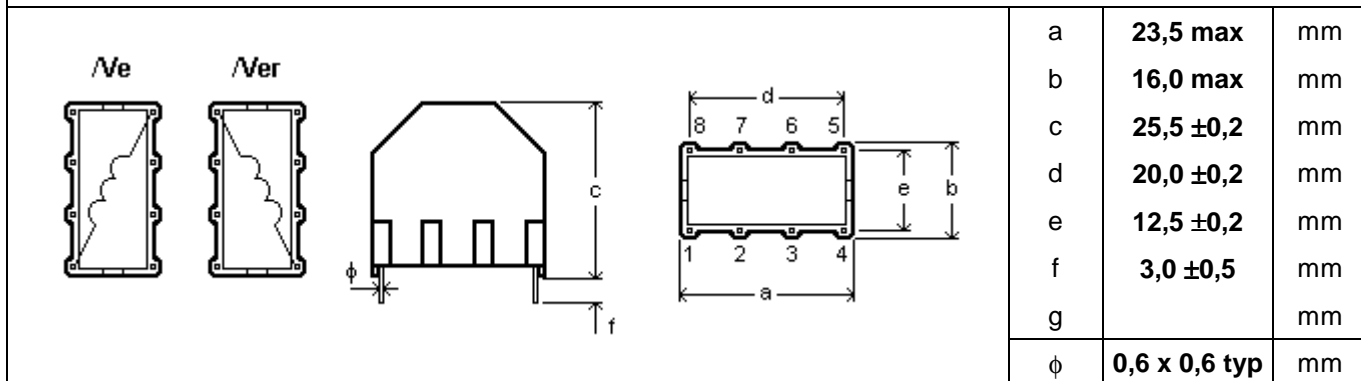

ELEKTRICKÉ VLASTNOSTI / ELECTRICAL PROPERTIES / ELEKTRISCHE EIGENSCHAFTEN

MĚŘICÍ PODMÍNKY TEST CONDITIONS MESSBEDINGUNGEN	10 kHz, 50 mV, 25 °C	L_o	180	μH	± 20 %
		I_N	1,4	A	max
	25 °C	R_{DC}	120	mΩ	typ

JINÉ VLASTNOSTI / OTHER PROPERTIES / ANDERE EIGENSCHAFTEN

JÁDRO CORE KERN	Sendust	KLIMATICKÁ ODOLNOST CLIMATIC CATEGORY KLIMABESTÄNDIGKEIT	40/125/21	SCHVÁLENO APPROVED KONTROLLIERT 
POUZDRO CASE GEHÄUSE	UL94V-0	ZKUŠEBNÍ NAPĚTÍ TESTING VOLTAGE PRÜFSPANNUNG		
ZALITÍ RESIN VERGUß	UL94V-0	JMENOVITÉ NAPĚTÍ RATED VOLTAGE NENNSPANNUNG		
DRÁT WIRE DRAHT	UL94V-0	OTEPLENÍ OVERTEMPERATURE ÜBERTEMPERATUR	< 55 °C	
		IZOLAČNÍ ODPOR INSULATING RESISTANCE ISOLATIONSWIDERSTAND	50 MΩ, 500 V_{DC}	

THE CHOKES ARE DESIGNED AND TESTED IN ACCORDANCE WITH EN 60938-1.
 THE CASES ARE OF FLAME-RETARDANT PLASTIC MATERIAL IN ACCORDANCE WITH UL 94V-0.