

SPECIFIKACE / SPECIFICATION / SPEZIFIKATION

   	<p>PMEC spol. s r.o. nám. Republiky 8, 787 01 Šumperk, Czech Republic Phone 00420 583 216 582 www.pmec.cz info@pmec.cz</p>
---	--

TYPOVÉ OZNAČENÍ / ARTICLE NUMBER / ARTIKELNUMMER	DATUM / DATE / DATUM
--	----------------------

PMEC 104/H 22m 1,7 A	2010-09-23
-----------------------------	-------------------

POPIS / DESCRIPTION / BEZEICHNUNG	
-----------------------------------	--

Proudově kompenzované odrušovací tlumivky
Current-compensated noise suppression chokes
Stromkompensierte Funkentstördrosseln

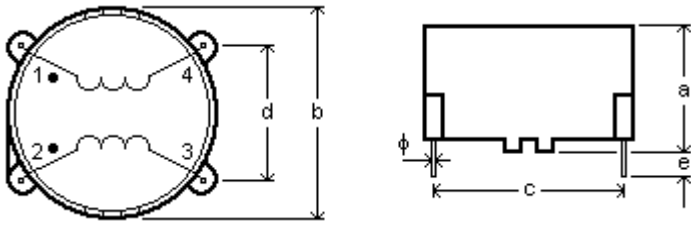

ROZMĚRY (ZDOLA) / DIMENSIONS (FROM BELLOW) / ABMESSUNGEN (VON UNTEN)
--

	<table border="1" style="width: 100%; border-collapse: collapse;"> <tr><td>a</td><td>20,0 max</td><td>mm</td></tr> <tr><td>b</td><td>33,0 max</td><td>mm</td></tr> <tr><td>c</td><td>30,2 ±0,2</td><td>mm</td></tr> <tr><td>d</td><td>20,1 ±0,2</td><td>mm</td></tr> <tr><td>e</td><td>3,0 ±0,5</td><td>mm</td></tr> <tr><td>f</td><td></td><td>mm</td></tr> <tr><td>g</td><td></td><td>mm</td></tr> <tr><td>φ</td><td>0,8 x 0,8 typ</td><td>mm</td></tr> </table>	a	20,0 max	mm	b	33,0 max	mm	c	30,2 ±0,2	mm	d	20,1 ±0,2	mm	e	3,0 ±0,5	mm	f		mm	g		mm	φ	0,8 x 0,8 typ	mm
a	20,0 max	mm																							
b	33,0 max	mm																							
c	30,2 ±0,2	mm																							
d	20,1 ±0,2	mm																							
e	3,0 ±0,5	mm																							
f		mm																							
g		mm																							
φ	0,8 x 0,8 typ	mm																							

ELEKTRICKÉ VLASTNOSTI / ELECTRICAL PROPERTIES / ELEKTRISCHE EIGENSCHAFTEN

MĚŘICÍ PODMÍNKY TEST CONDITIONS MESSBEDINGUNGEN	10 kHz, 50 mV, 25 °C	L_o	22	mH	-30+40%
	< 60 °C	I_N	1,7	A	max
	25 °C	R_{DC}	270	mΩ	typ

JINÉ VLASTNOSTI / OTHER PROPERTIES / ANDERE EIGENSCHAFTEN				SCHVÁLENO APPROVED KONTROLLIERT
---	--	--	--	---------------------------------------

JÁDRO CORE KERN	Ferit / Ferrite / Ferrit	KLIMATICKÁ ODOLNOST CLIMATIC CATEGORY KLIMABESTÄNDIGKEIT	40/125/21	
POUZDRO CASE GEHÄUSE	UL94V-0	ZKUŠEBNÍ NAPĚTÍ TESTING VOLTAGE PRÜFSPANNUNG	1500 V_{ef}, 50 Hz	
ZALITÍ RESIN VERGUß	UL94V-0	JMENOVITÉ NAPĚTÍ RATED VOLTAGE NENNSPANNUNG	250 V_{ef}, 50 Hz	
DRÁT WIRE DRAHT	UL94V-0	OTEPLENÍ OVERTEMPERATURE ÜBERTEMPERATUR	< 55 °C	
		IZOLAČNÍ ODPOR INSULATING RESISTANCE ISOLATIONSWIDERSTAND	50 MΩ, 500 V_{DC}	

THE CHOKES ARE DESIGNED AND TESTED IN ACCORDANCE WITH EN 60938-1.
 THE CASES ARE OF FLAME-RETARDANT PLASTIC MATERIAL IN ACCORDANCE WITH UL 94V-0.