

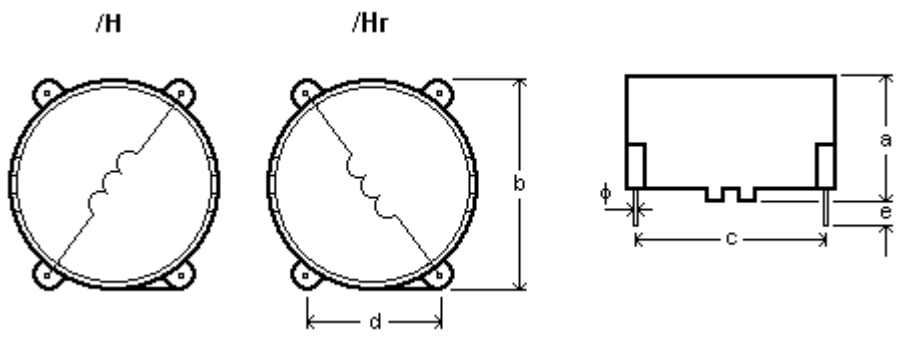



SPECIFIKACE / SPECIFICATION / SPEZIFIKATION

		PMEC spol. s r.o. nám. Republiky 8, 787 01 Šumperk, Czech Republic Phone 00420 583 216 582 www.pmec.cz info@pmec.cz				
TYPOVÉ OZNAČENÍ / ARTICLE NUMBER / ARTIKELNUMMER			DATUM / DATE / DATUM			
PMEC 221/H 180u 1,0 A			2010-08-23			
POPIS / DESCRIPTION / BEZEICHNUNG						
Odušovací tlumivky/Akumulační tlumivky Noise suppression chokes/Storage chokes Funkentstördrosseln/Speicherdrosseln						
ROZMĚRY (ZDOLA) / DIMENSIONS (FROM BELLOW) / ABMESSUNGEN (VON UNTEN)						
			a	13,0 max	mm	
			b	18,0 max	mm	
			c	15,0 ±0,2	mm	
			d	10,0 ±0,2	mm	
			e	3,0 ±0,5	mm	
			f		mm	
			g		mm	
			φ	0,6 x 0,6 typ	mm	
ELEKTRICKÉ VLASTNOSTI / ELECTRICAL PROPERTIES / ELEKTRISCHE EIGENSCHAFTEN						
MĚŘICÍ PODMÍNKY TEST CONDITIONS MESSBEDINGUNGEN		10 kHz, 50 mV, 25 °C	L_o	180	μH	± 20 %
		50 Hz, 60 °C	I_N	1,0	A	max
		25 °C	R_{DC}	360	mΩ	typ
JINÉ VLASTNOSTI / OTHER PROPERTIES / ANDERE EIGENSCHAFTEN						
JÁDRO CORE KERN	Železoprach Ironpowder Eisenpulver	KLIMATICKÁ ODOLNOST CLIMATIC CATEGORY KLIMABESTÄNDIGKEIT	40/125/21	SCHVÁLENO APPROVED KONTROLLIERT		
POUZDRO CASE GEHÄUSE	UL94V-0	ZKUŠEBNÍ NAPĚTÍ TESTING VOLTAGE PRÜFSPANNUNG				
ZALITÍ RESIN VERGUß	UL94V-0	JMENOVITÉ NAPĚTÍ RATED VOLTAGE NENNSPANNUNG				
DRÁT WIRE DRAHT	UL94V-0	OTEPLENÍ OVERTEMPERATURE ÜBERTEMPERATUR	< 55 °C			
		IZOLAČNÍ ODPOR INSULATING RESISTANCE ISOLATIONSWIDERSTAND	50 MΩ, 500 V_{DC}			

THE CHOKES ARE DESIGNED AND TESTED IN ACCORDANCE WITH EN 60938-1.
 THE CASES ARE OF FLAME-RETARDANT PLASTIC MATERIAL IN ACCORDANCE WITH UL 94V-0.